



INSTALLATION GUIDE

23+ / FORD SUPER DUTY HONEY BADGER FRONT BUMPER

F810211770103



TOOLS REQUIRED

(Socket) 5/16, 5/32, 9/16, 3/4, 15mm, 18mm
(Wrench) 5/16, 5/32, 9/16, 3/4, 15mm, 18mm
(Allen) 7/32, 5/16
Fastener Removal Tool/Flathead
Flat File



TIME REQUIRED

- 3 hours for OEM Removal/Bumper Install
-1 Additional Hour to Wire Lights

****Labor Rates are based on a vehicle with no pre-existing damage. Wiring labor is based on a standard wiring procedure with light switches installed in an easily accessible location. Custom light triggering or switch mounting location will result in a greater labor charge.****



SKILL LEVEL



Easy

****This installation requires 2 people for best results****

⚠️ WARNINGS/CAUTIONS BEFORE STARTING INSTALLATION ⚠️

-BEFORE YOU INSTALL THIS KIT-

Read and understand all instructions, warnings, cautions, & notes contained in this installation instruction guide. Consult your vehicle owner's manual for proper disconnection of electrical and lifting of vehicle if required for installation of this product.

This install may require some technical skills and knowledge of basic mechanical work. If you do not feel that you are capable of performing this install please take this product to a trained professional.

After reading this guide please contact us with any questions or concerns before installing product.
Customer Service (480) 671-0820

Addictive desert designs is *not* responsible for any bodily injury or harm to you or your vehicle as a result of an improper install.

Proper installation of this kit required knowledge of the factory recommended procedures for removal and installation of original equipment components.

We recommend that the factory shop manual and any special tools needed to service your vehicle be on hand during the installation. Installation of this kit without proper knowledge of the factory recommended procedures may affect the performance of these components and the safety of the vehicle.

Inspect all contents of this package to make sure product is not damaged and all installation hardware has been included. If parts are missing from kit, please be prepared to provide the following information:

1. Name of purchase location
2. Bar Code on side of box
3. Date above bar code
4. Date inside box cover

ALWAYS WEAR EYE PROTECTION WHEN OPERATING POWER TOOLS

HARDWARE

A.

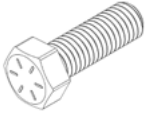

3/8-16 X 1 1/4" HEX HEAD BOLT GRADE 8

QTY: 4

A1.



3/8" FENDER WASHER

QTY: 4

A2.

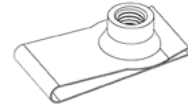

3/8-16 U-NUT

QTY: 4

B.

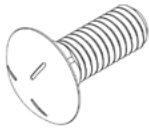

3/8-16 X 1" CARRIAGE BOLT

QTY: 4

B1.



3/8 FLAT WASHER

QTY: 4

B2.



3/8-16 NYLON LOCK NUT

QTY: 4

C.

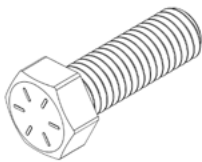

1/2-13 X 1 1/2" HEX HEAD GRADE 8

QTY: 12

C1.



1/2-13 X 1 1/2" BUTTON HEAD BOLT

QTY: 2

C2.



1/2" FLAT WASHER

QTY: 24

C3.

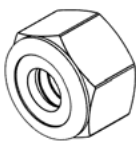

1/2-13" NYLON LOCK NUT

QTY: 12

SENSOR GROMMETS SUPPLIED FOR NON SENSOR TRIMS



3/4" RUBBER SENSOR GROMMET

QTY: 4



3/4" PLASTIC SENSOR GROMMET PLUG

QTY: 4



INSTALLATION **GUIDE**

HONEY BADGER FRONT BUMPER 23+/**FORD SUPER DUTY**

REMOVAL

□ STEP 1

Unplug the wiring harness located behind the bumper on the driver side frame rail.





INSTALLATION **GUIDE**

HONEY BADGER FRONT BUMPER 23+/**FORD SUPER DUTY**

REMOVAL

STEP 2

Using a (fastener removal tool/flathead screwdriver) remove the clips holding the plastic molding.

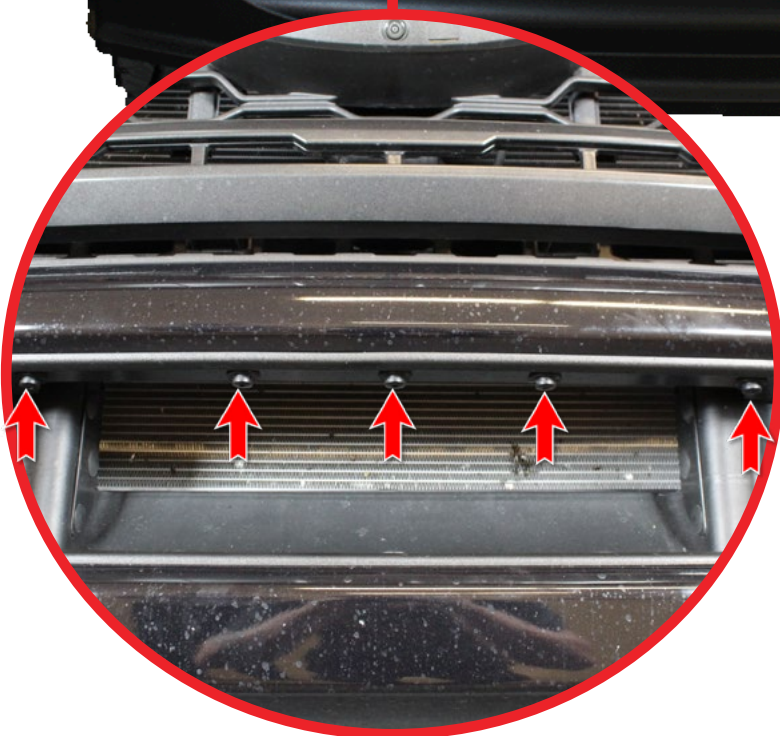



INSTALLATION GUIDE

HONEY BADGER FRONT BUMPER 23+/FORD SUPER DUTY

REMOVAL

□ STEP 3

Pull the plastic off to expose the mounting bolt.





INSTALLATION GUIDE

HONEY BADGER FRONT BUMPER 23+ / FORD SUPER DUTY

REMOVAL

□ STEP 4

Locate the ACC module and remove the plug-in by pushing the tab down on the backside, next remove the bolts holding the ACC using a (5/32 socket). ****set the ACC aside and reference the ACC guide when the bumper is removed****





INSTALLATION GUIDE

HONEY BADGER FRONT BUMPER
23+ / FORD SUPER DUTY

REMOVAL

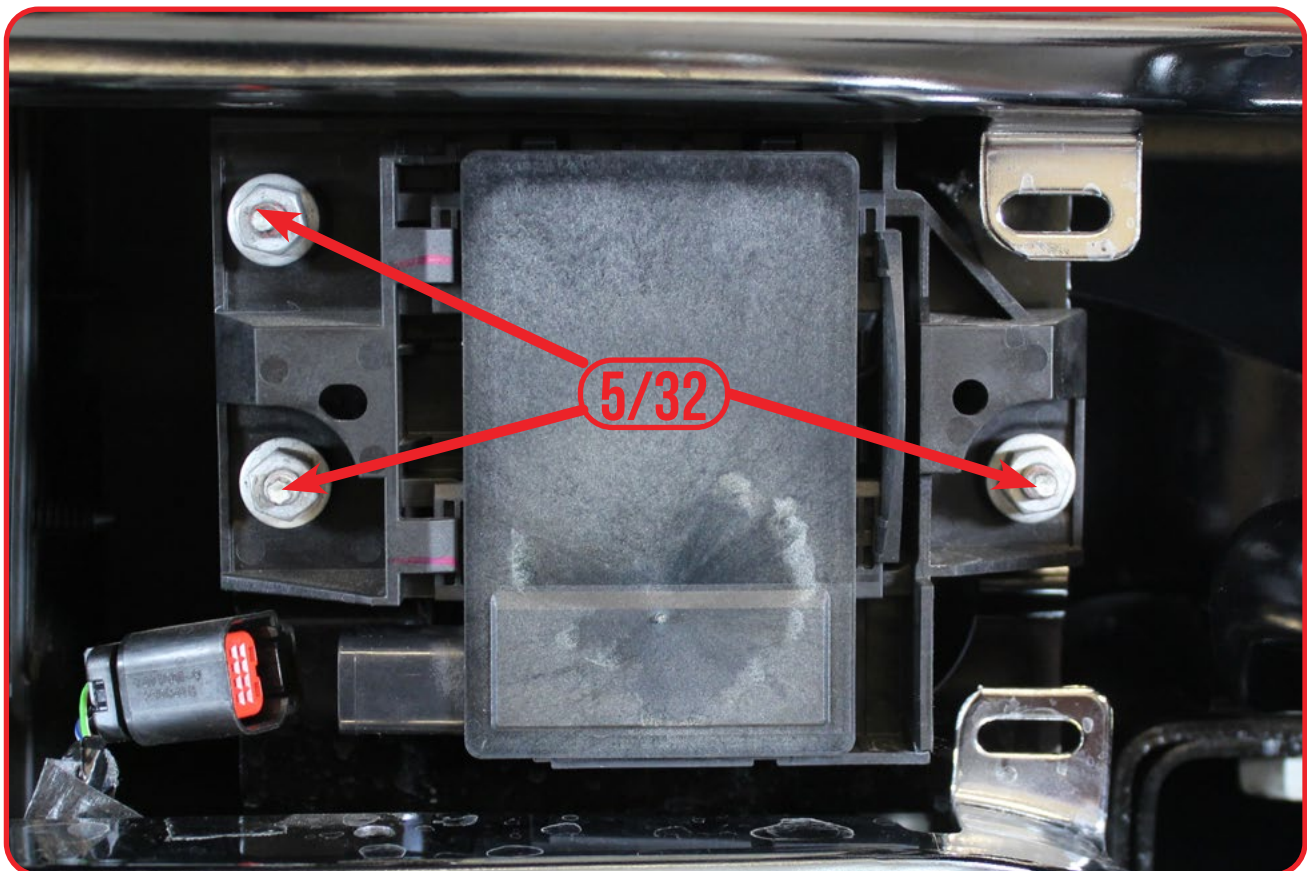
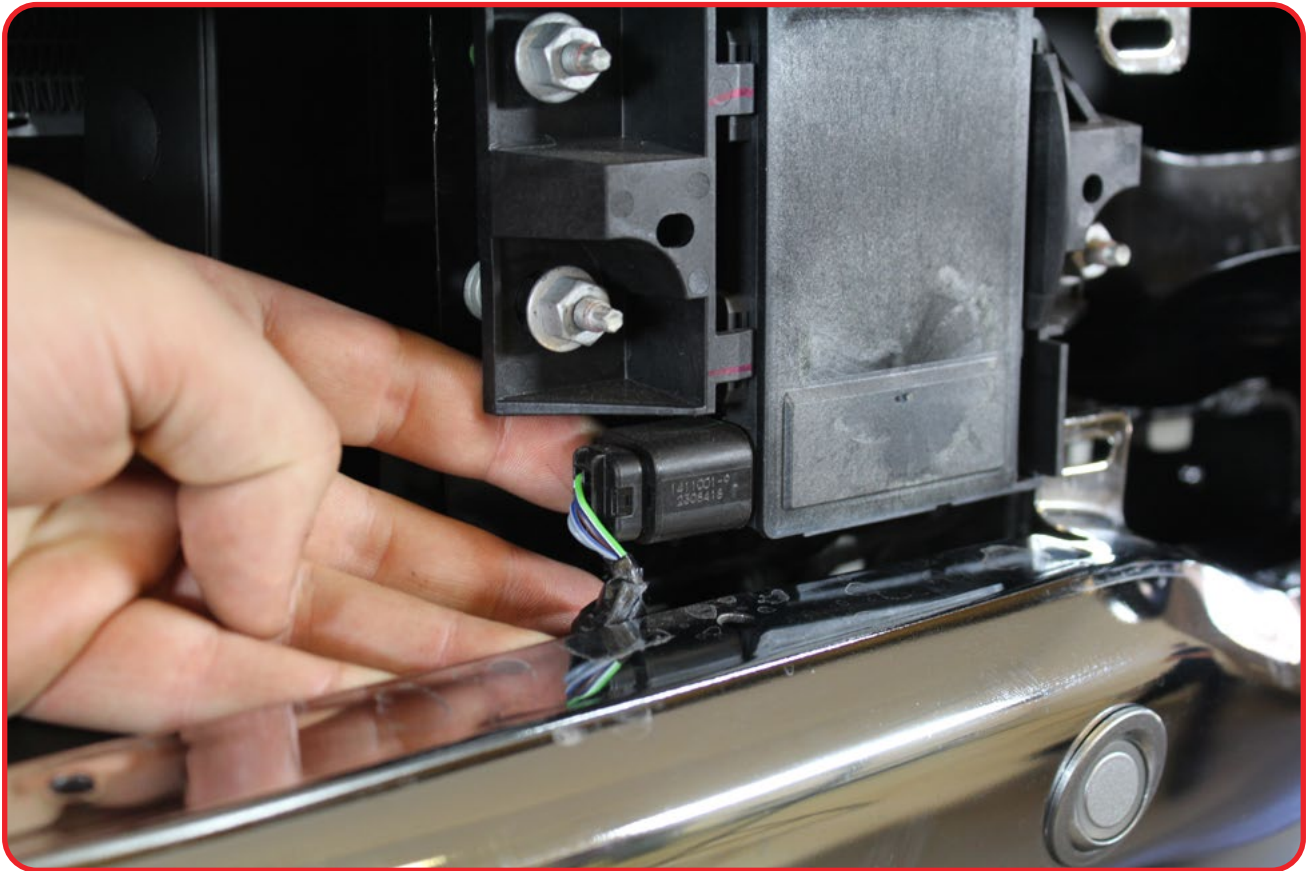



INSTALLATION GUIDE

HONEY BADGER FRONT BUMPER 23+ / FORD SUPER DUTY

REMOVAL

□ STEP 5

Remove the two bolts per side along with the nut clips that are located behind the bumper along the frame rail using a (15mm Socket).





INSTALLATION GUIDE

HONEY BADGER FRONT BUMPER 23+ / FORD SUPER DUTY

REMOVAL

□ STEP 6

Remove the four mounting bolts on each side using a (18mm Socket) and remove the plastic push pin located between the bumper and grill using a (fastener removal tool). You can now remove the stock bumper.





INSTALLATION **GUIDE**

HONEY BADGER FRONT BUMPER 23+/**FORD SUPER DUTY**

REMOVAL

STEP 7

Remove the 4x top tow hook mounting bolts and the 4x side tow hook mounting bolts using a (18mm Socket).

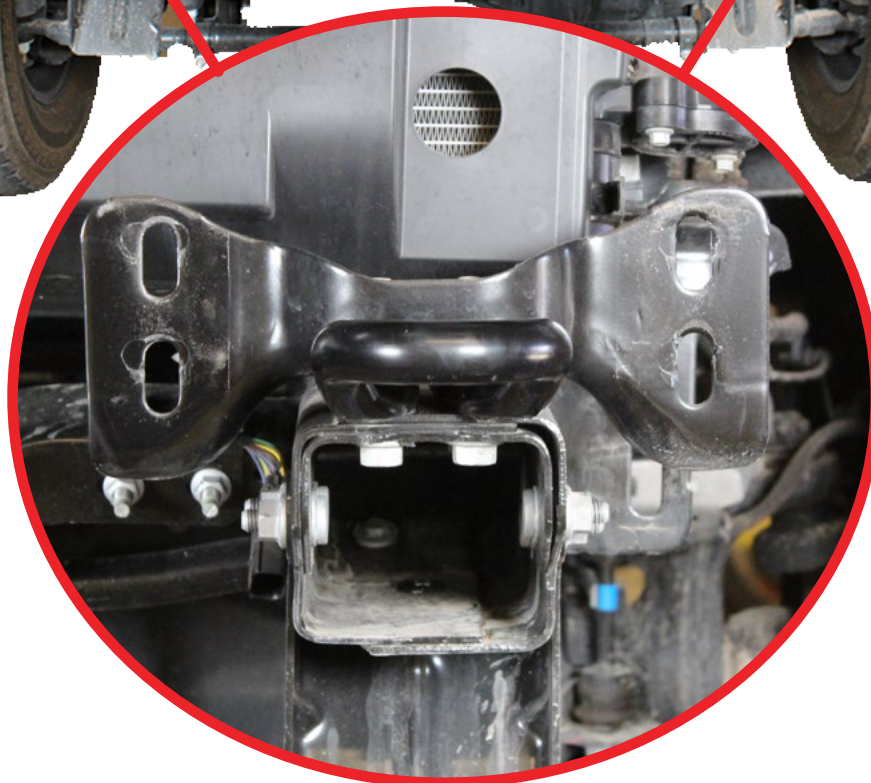



INSTALLATION **GUIDE**

HONEY BADGER FRONT BUMPER
23+ / FORD SUPER DUTY

REMOVAL

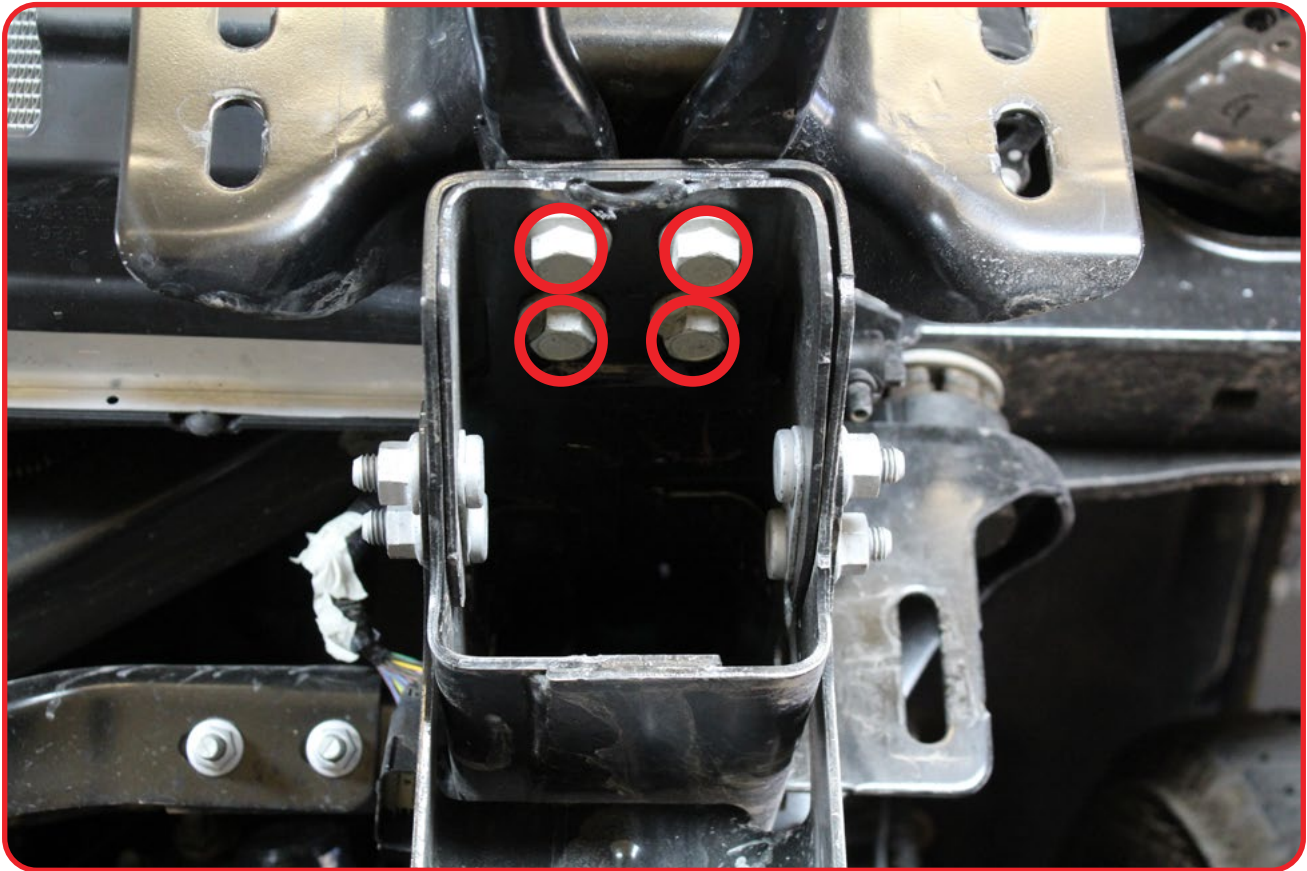



INSTALLATION GUIDE

HONEY BADGER FRONT BUMPER 23+/FORD SUPER DUTY

REMOVAL

□ STEP 8

Using a (fastener removal tool), remove the clips holding the shroud as shown below.



□ STEP 9

If your vehicle has a lower inner cooler, remove that shroud as well.



HONEY BADGER FRONT BUMPER 23+/FORD SUPER DUTY

REMOVAL

□ STEP 10

Remove the 4x bolts (each side) using a (5/16 socket).

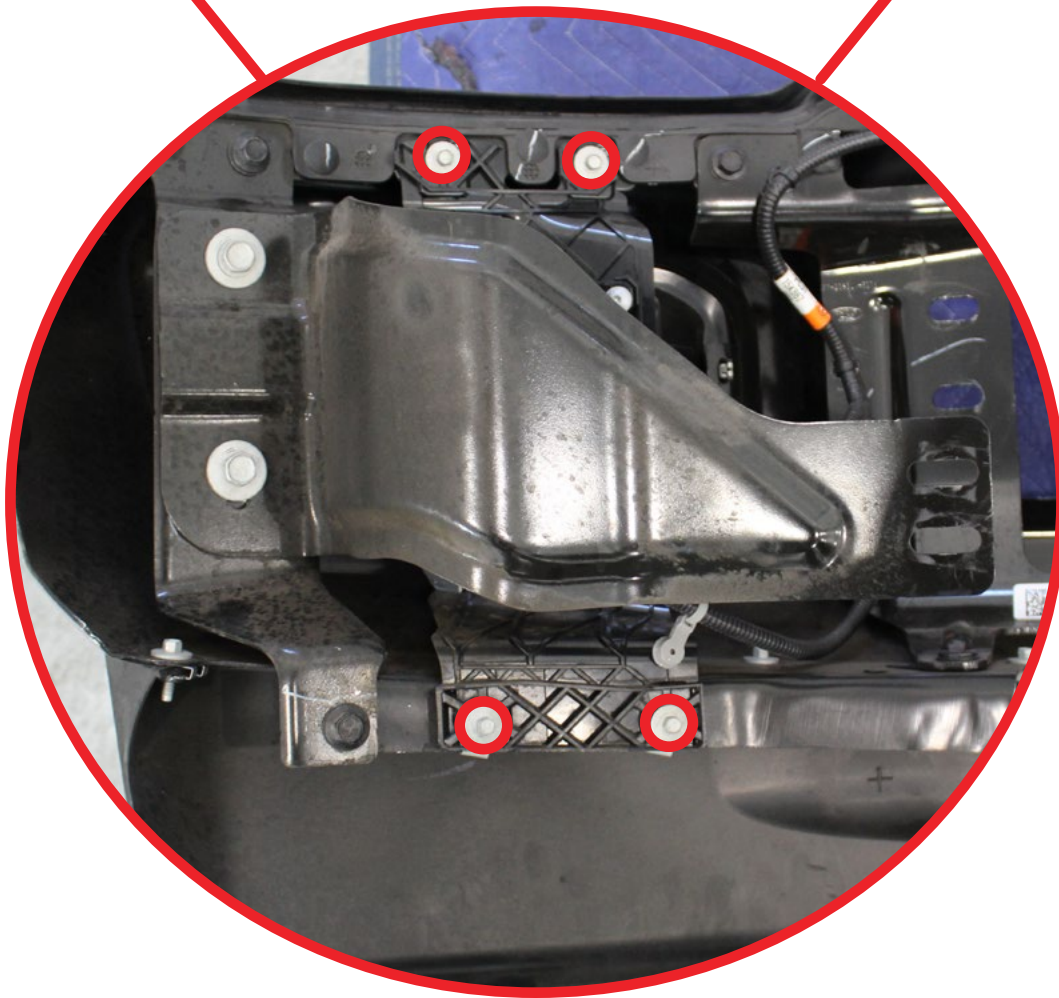
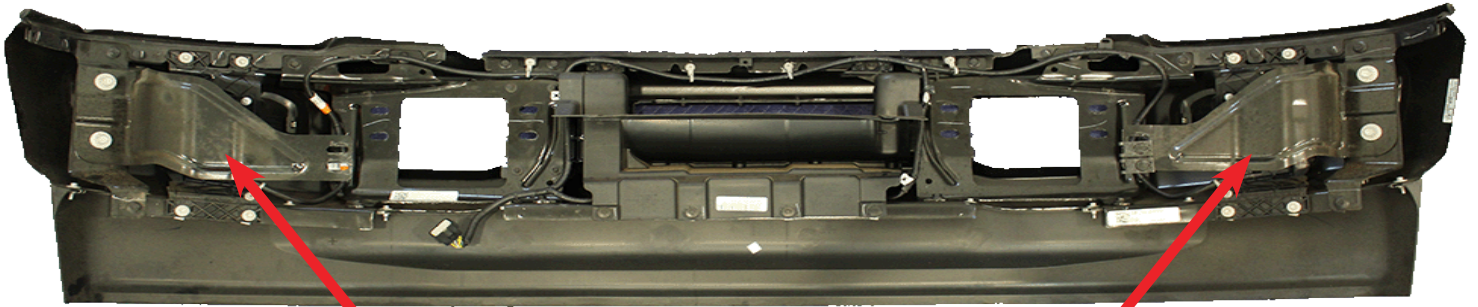

HONEY BADGER FRONT BUMPER 23+ / FORD SUPER DUTY

REMOVAL

□ STEP 11

Unplug the fog light as shown below.

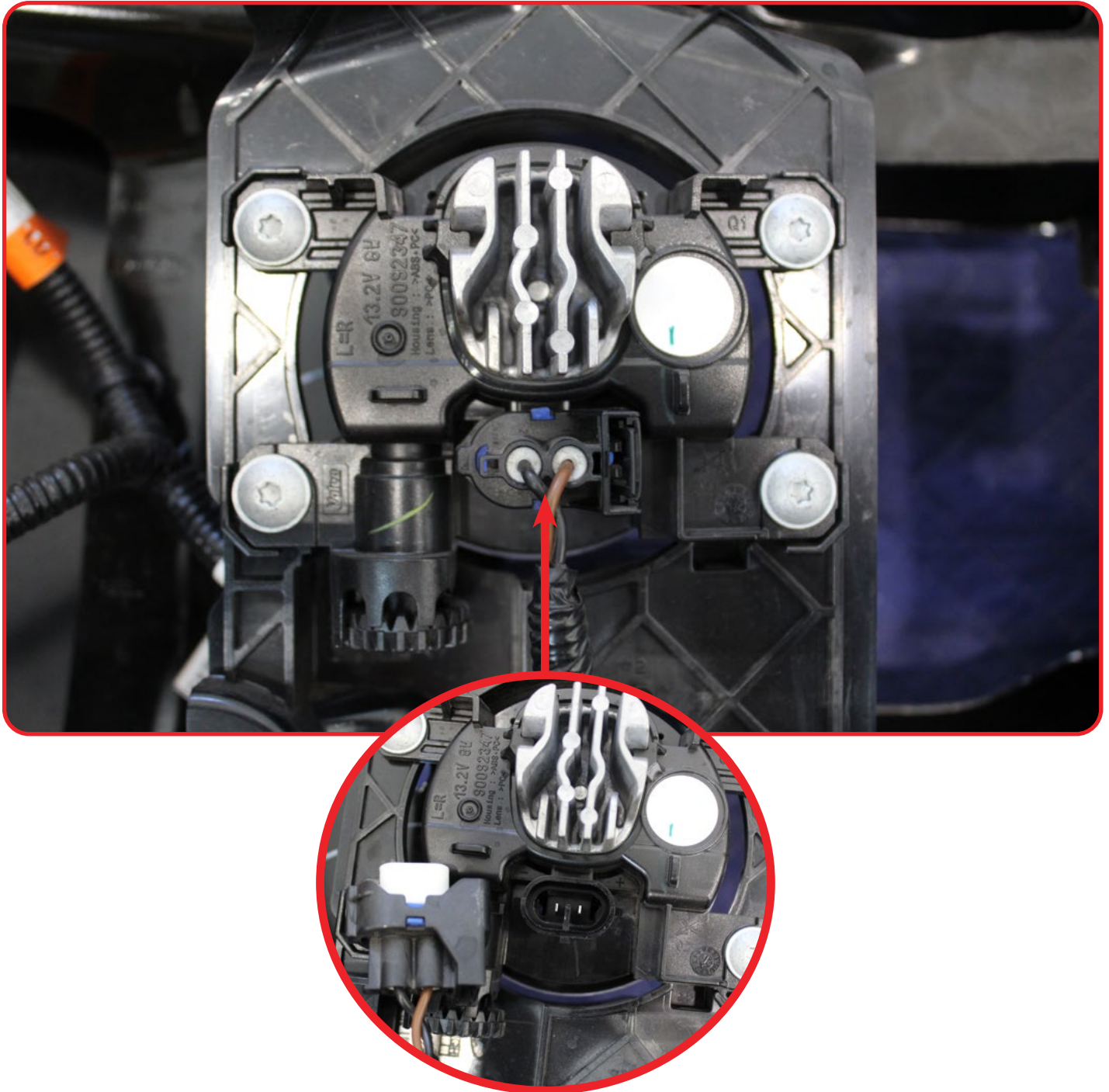

HONEY BADGER FRONT BUMPER 23+ / FORD SUPER DUTY

REMOVAL

□ STEP 12

Remove the 6x bolts as shown below using a (5/16 socket).

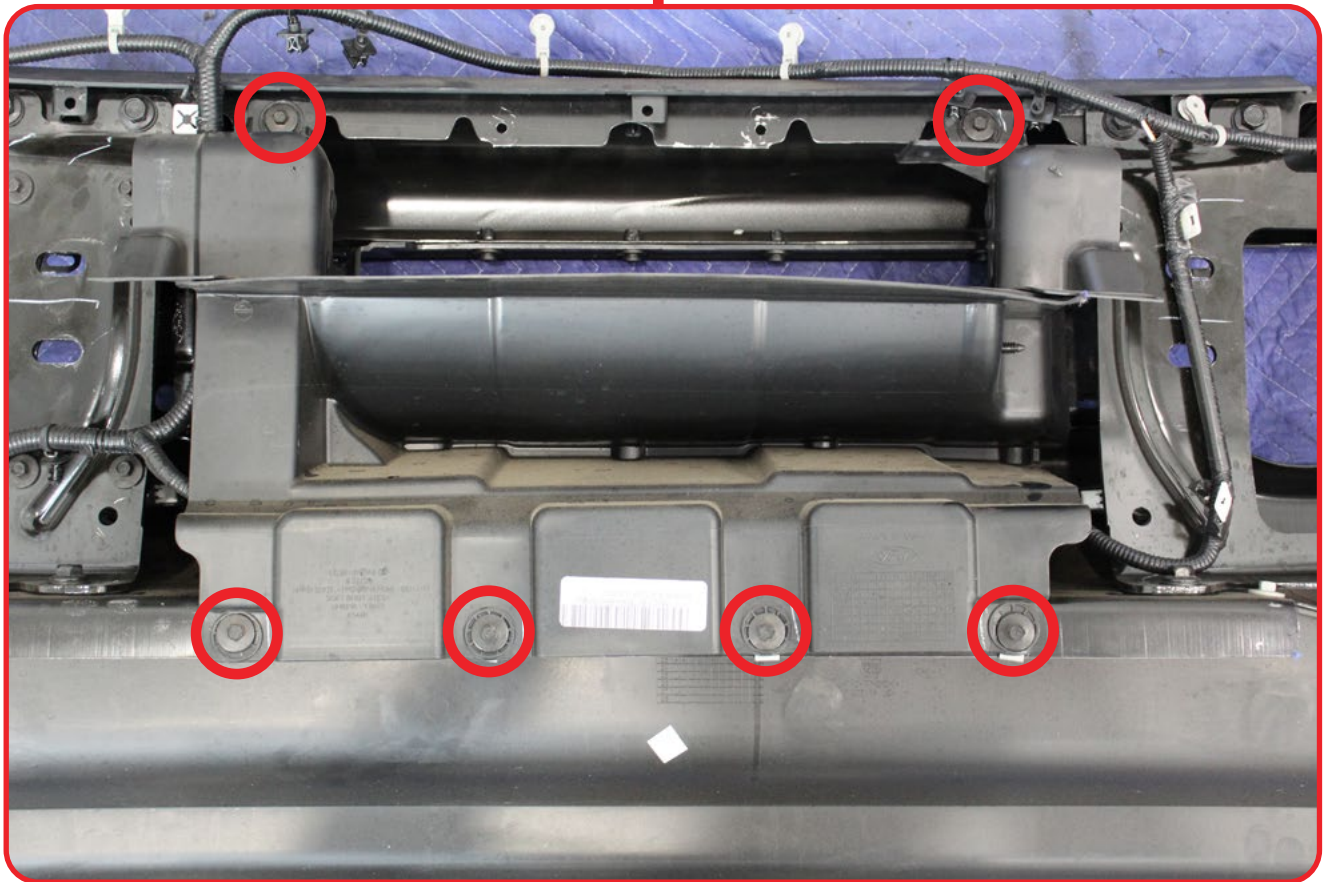
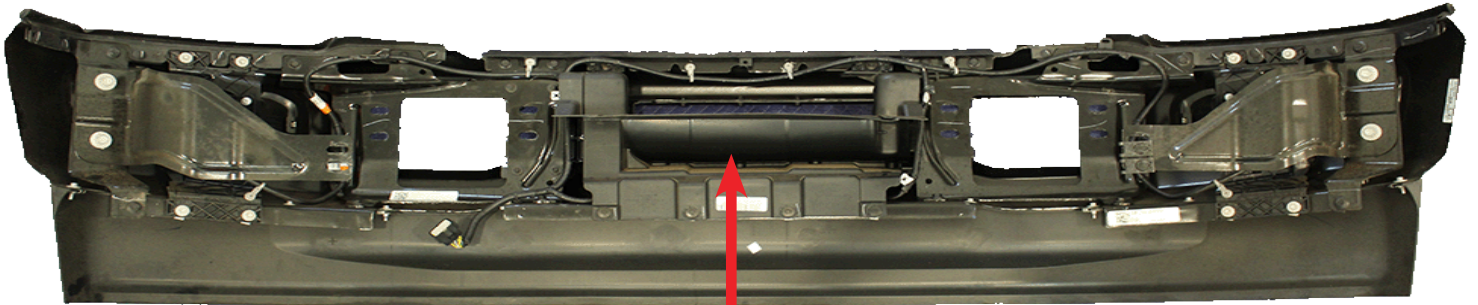

HONEY BADGER FRONT BUMPER 23+/FORD SUPER DUTY

REMOVAL

□ STEP 13

Remove the sensors from the bezels by spreading the tabs and pushing the sensor out.

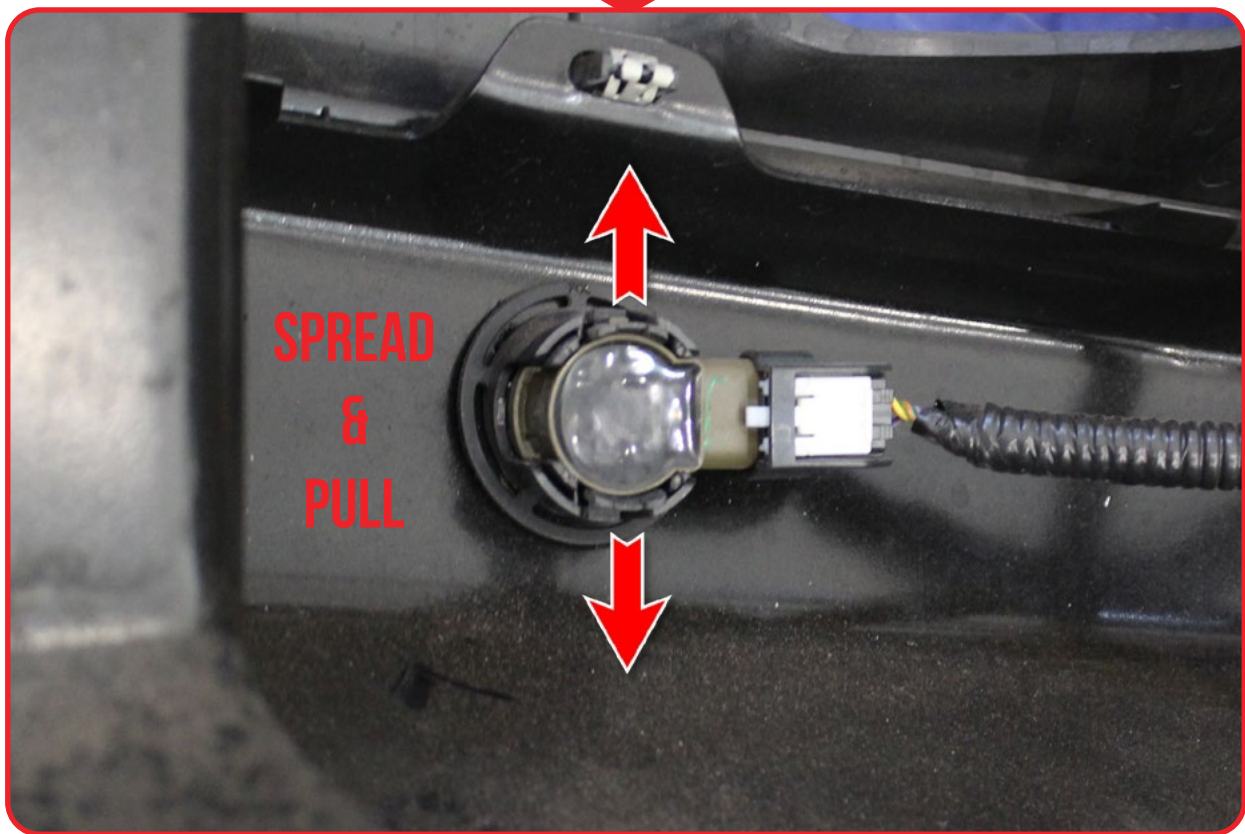
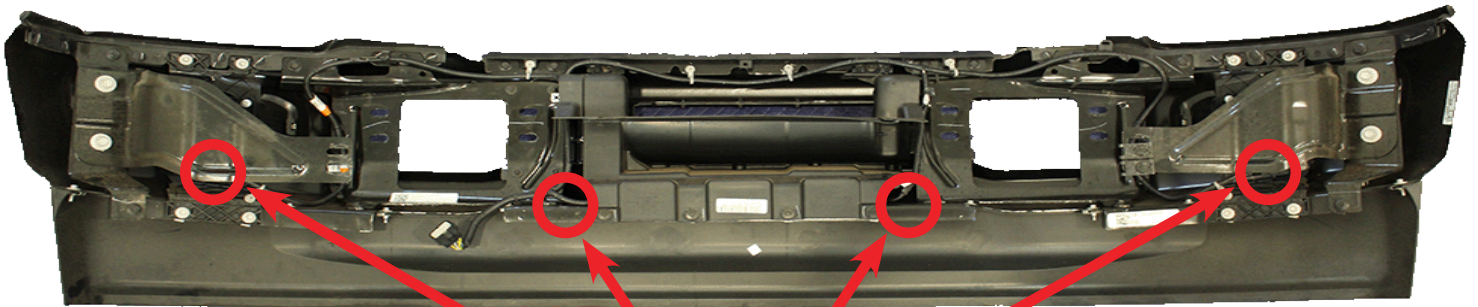



INSTALLATION GUIDE

HONEY BADGER FRONT BUMPER 23+ / FORD SUPER DUTY

REMOVAL

□ STEP 14

Remove the sensor bezels by pinching the bezel tabs in and pushing out towards the front of the bumper. ****REMEMBER THE ORIENTATION FOR IT WILL BE IMPORTANT LATER IN THE INSTALL****

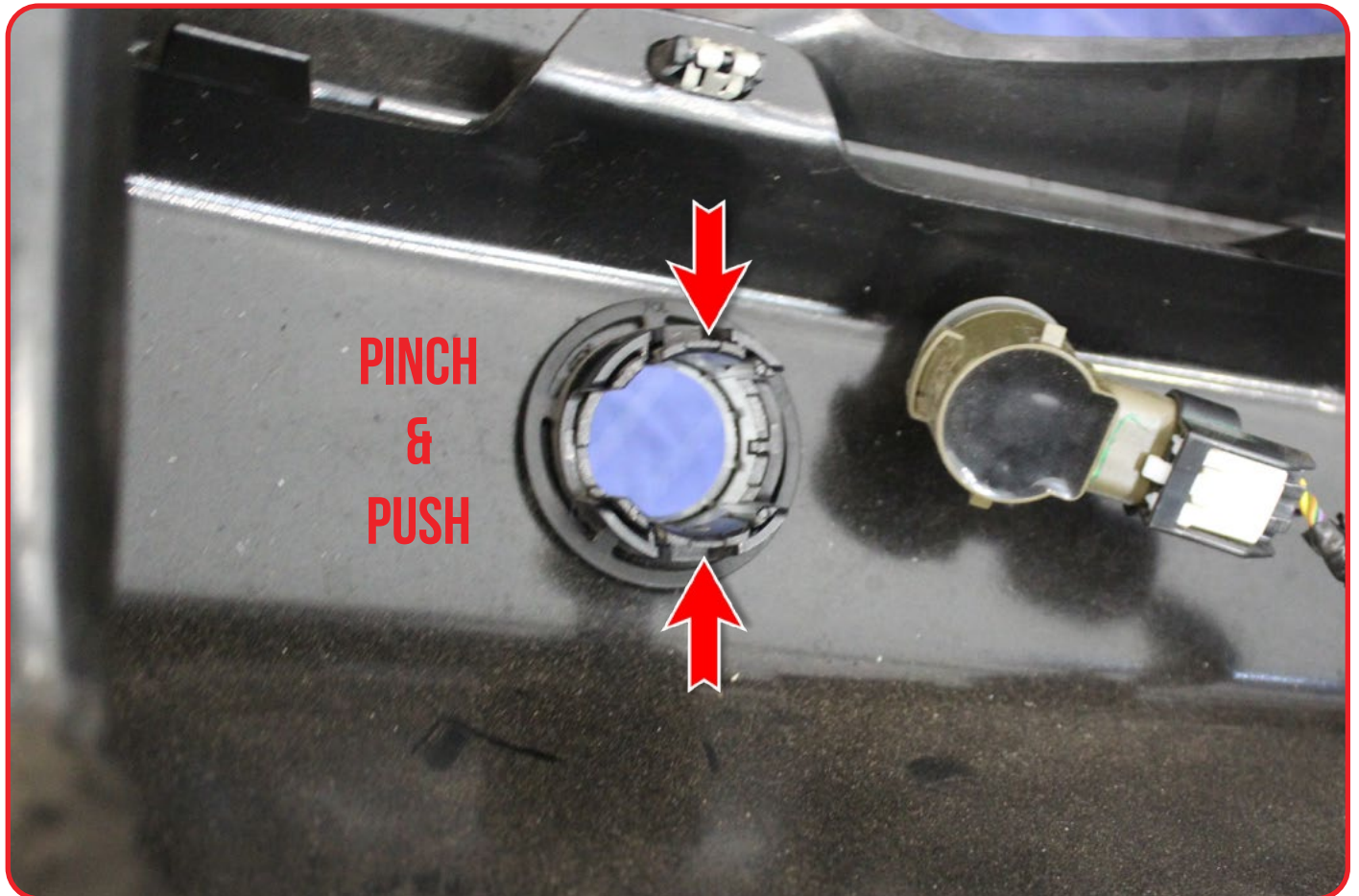



HONEY BADGER FRONT BUMPER 23+/FORD SUPER DUTY

REMOVAL

□ STEP 15

Using a (flat file), File the tabs located on the sensor bezel backer as shown below.



□ STEP 16

If your vehicle is equipped with Adaptive Cruise Control, relocate the sensor at this time with the ADD Relocation Bracket (part# AC81152501NA- sold separately).

<https://www.addictivedesertdesigns.com/cdn/shop/files/ADD-23-SuperDuty-ACC-InstallGuide.pdf?v=13468002646066146193>



INSTALLATION GUIDE

HONEY BADGER FRONT BUMPER 23+ / FORD SUPER DUTY

INSTALL

□ STEP 17

Using a (3/4 socket and wrench), install the mount plate by using the provided (C, C2, C3) 3/8 hardware to the back mounting holes.

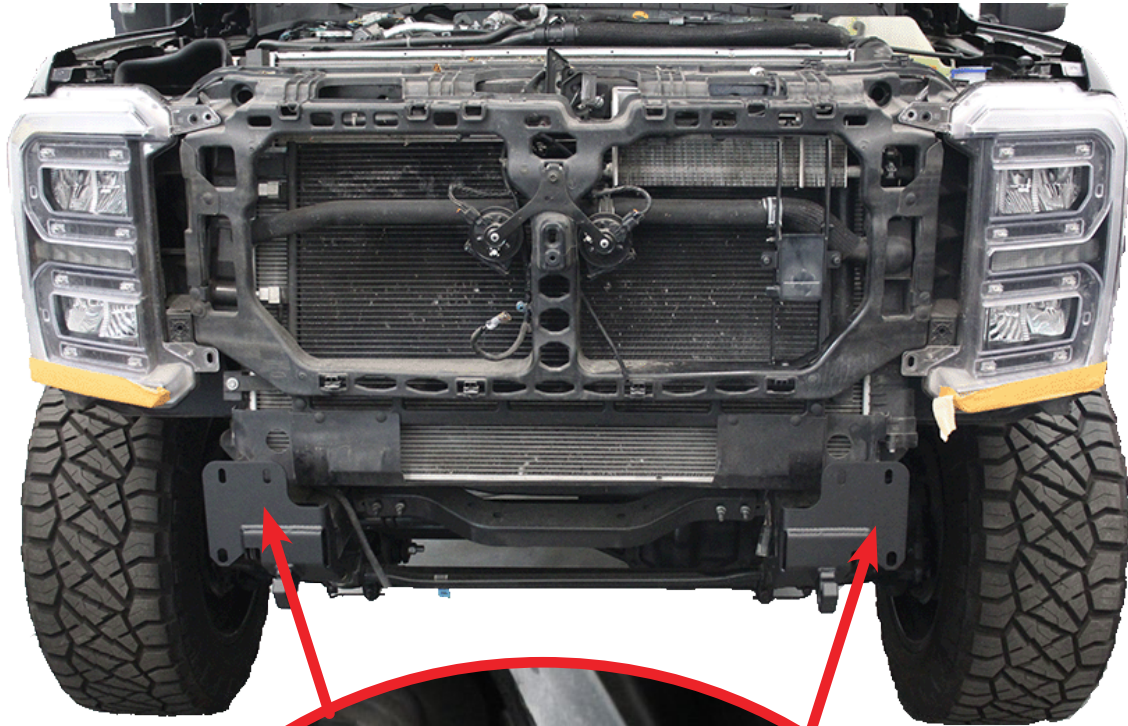

HONEY BADGER FRONT BUMPER 23+/FORD SUPER DUTY

INSTALL

□ STEP 18

Using a (3/4 socket) and a (3/4 Wrench) install the (C, C2, C3) hardware on top. Next install the OEM hardware removed from **step 7** using a (18mm socket).

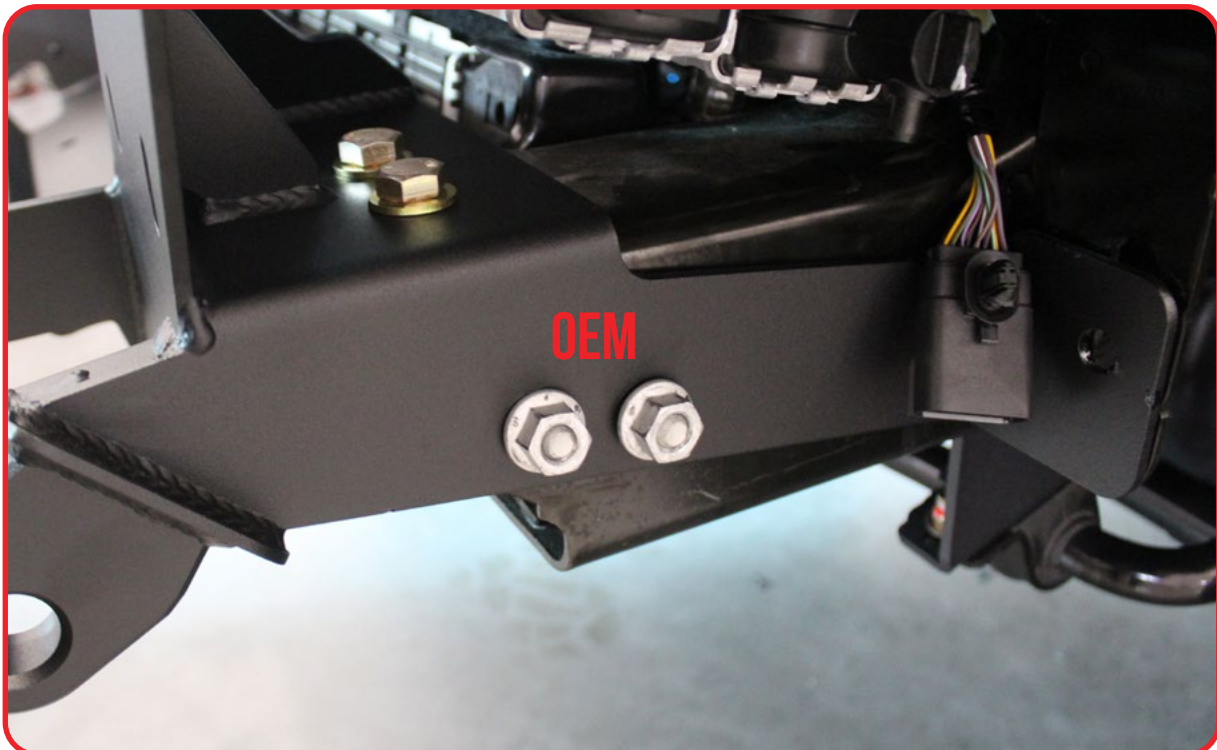
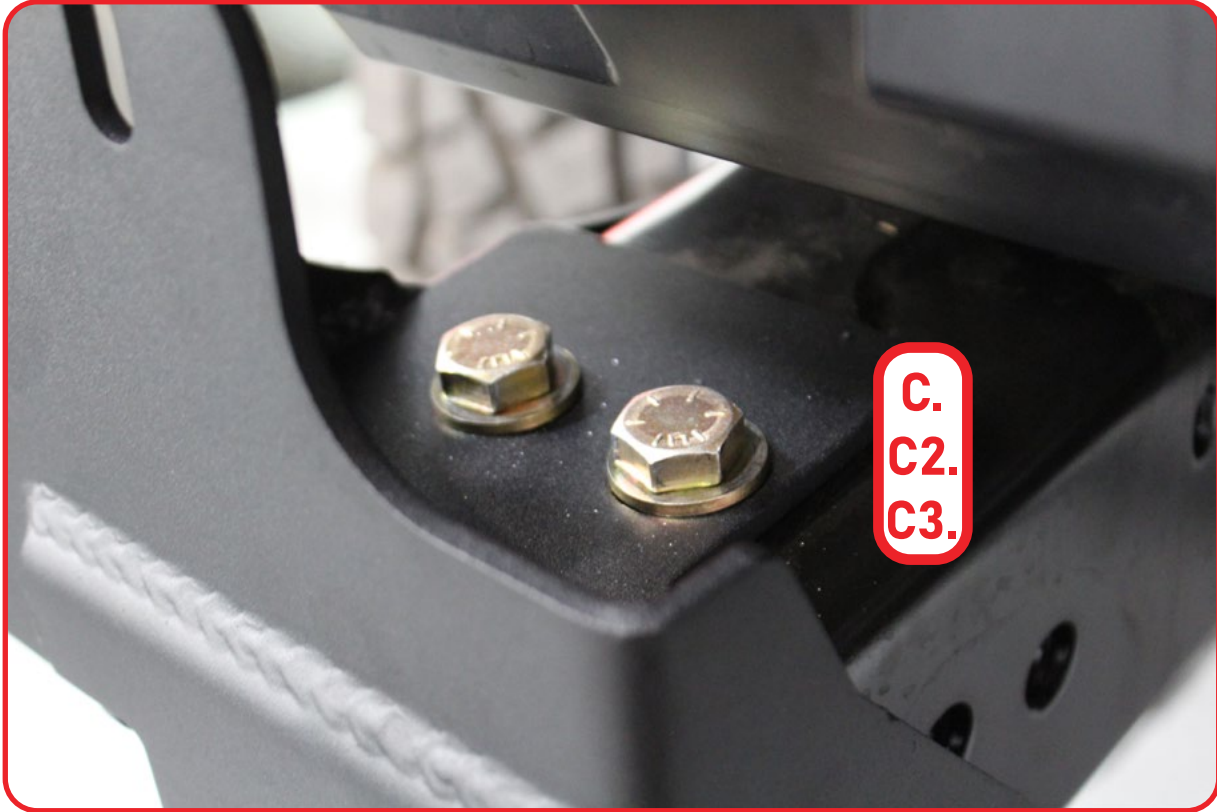

HONEY BADGER FRONT BUMPER 23+/FORD SUPER DUTY

INSTALL

□ STEP 19

Insert the (D) flag nut through the mounting bracket into the frame towards the back mounting hole located on the bottom of the mount as shown below and install the provided (C, C2) 1/2 hardware using a (3/4 socket).

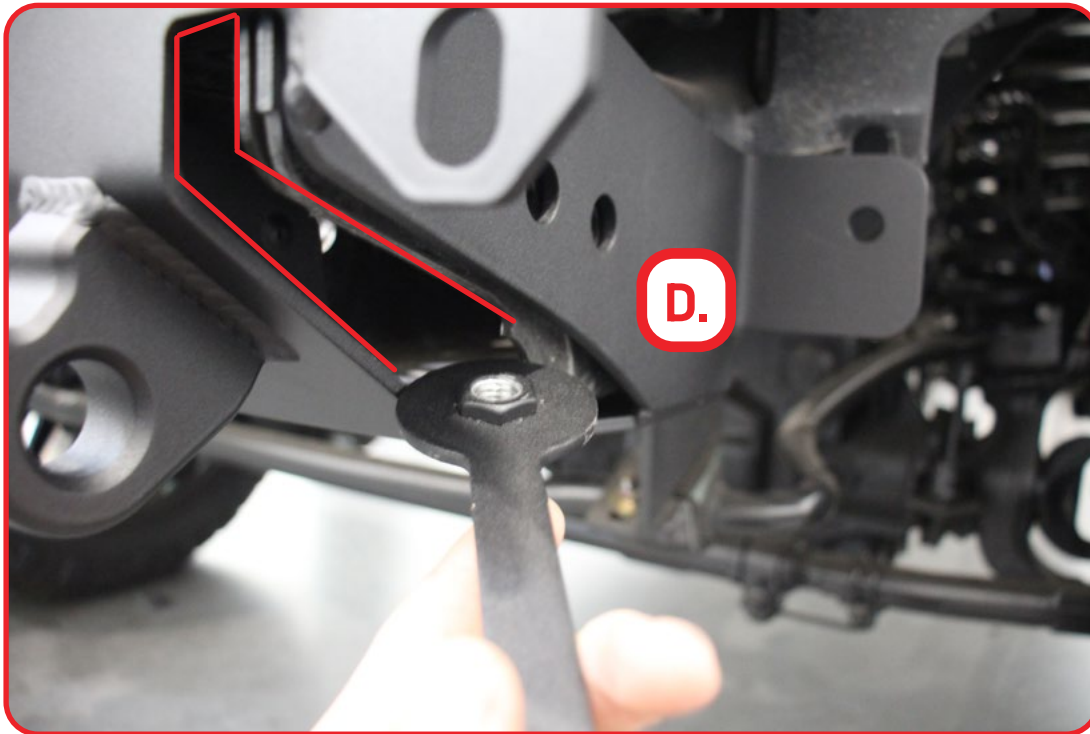

HONEY BADGER FRONT BUMPER 23+/FORD SUPER DUTY

INSTALL

□ STEP 20

Install the sensors/sensor bezels in the correct orientation removed from **step 13 & 14**.

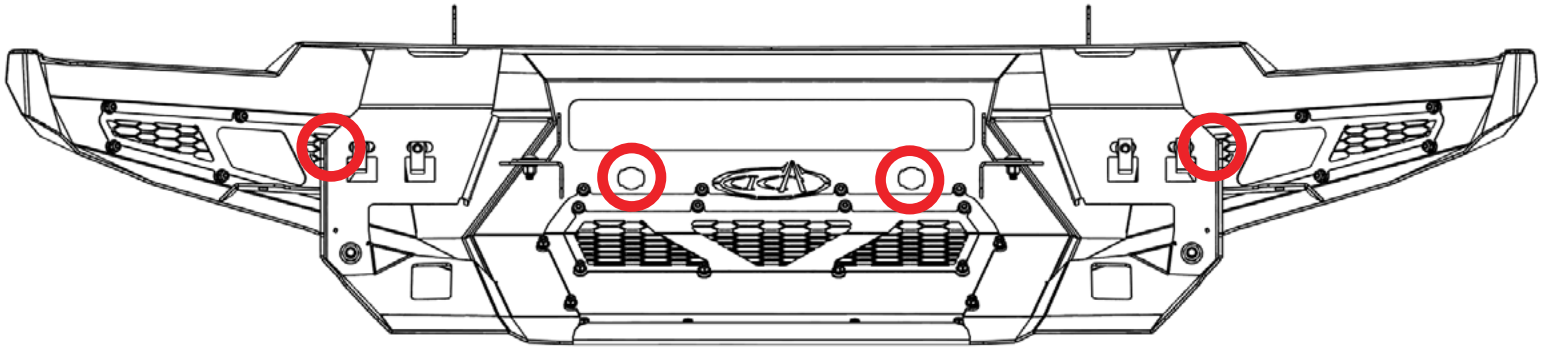



INSTALLATION GUIDE

HONEY BADGER FRONT BUMPER 23+/FORD SUPER DUTY

INSTALL

STEP 21

Install the 4x (A2) 3/8-16" nut clips.

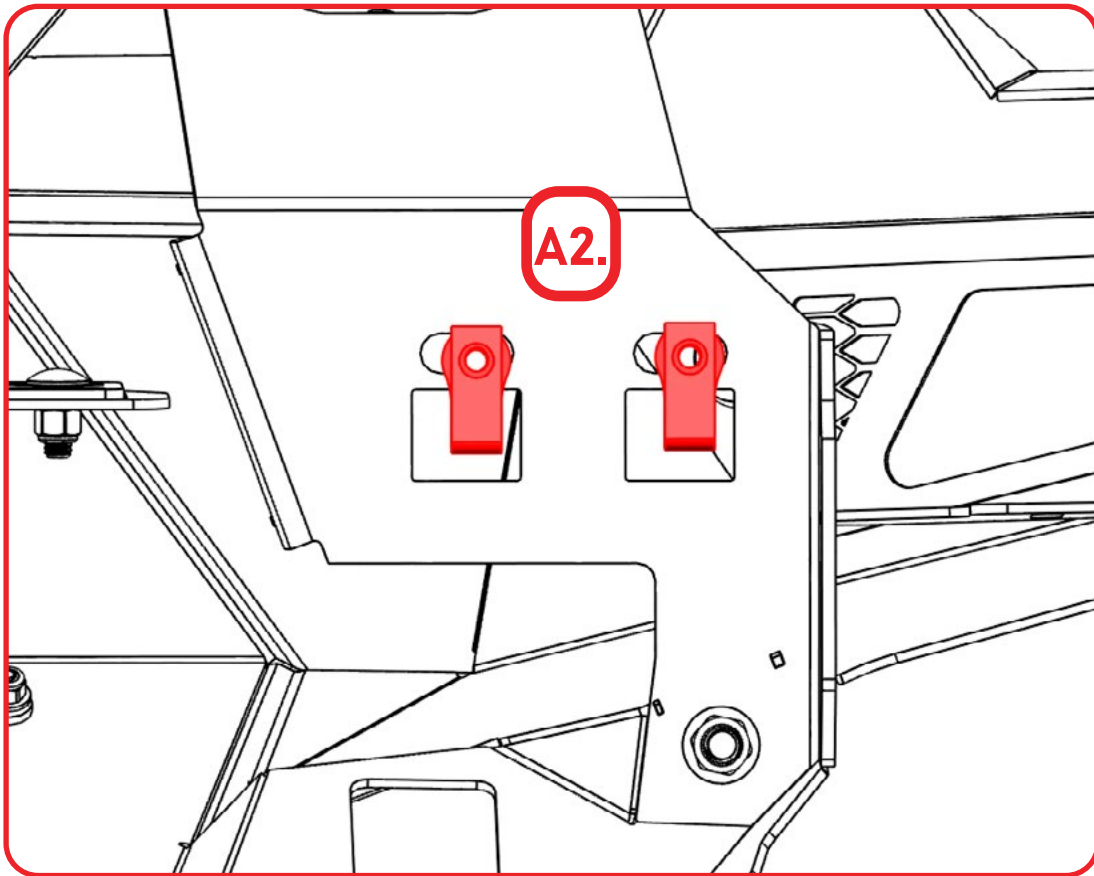
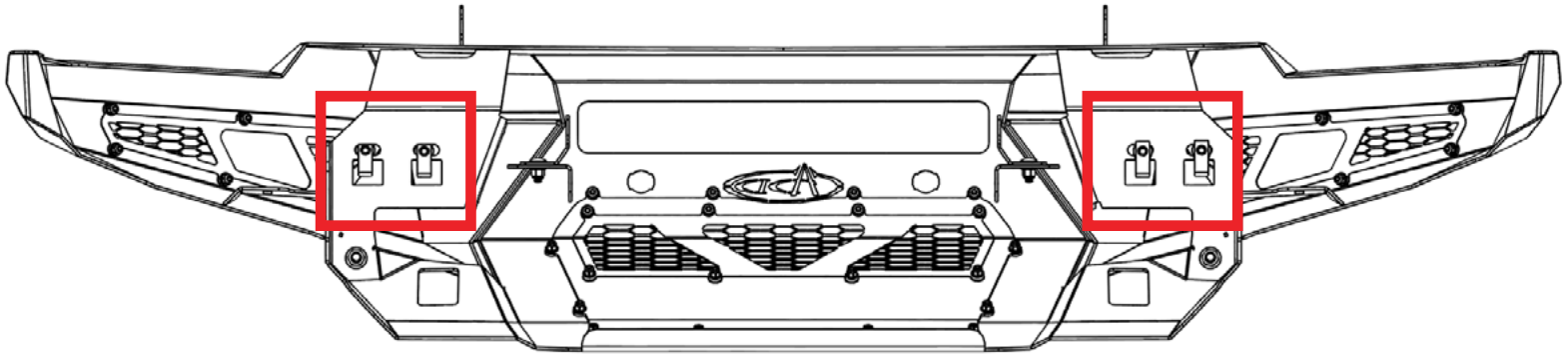



INSTALLATION GUIDE

HONEY BADGER FRONT BUMPER 23+ / FORD SUPER DUTY

INSTALL

□ STEP 22

Using a (9/16 wrench), Install the light brackets using the provided **(B, B1, B2)** 3/8 carriage bolts.

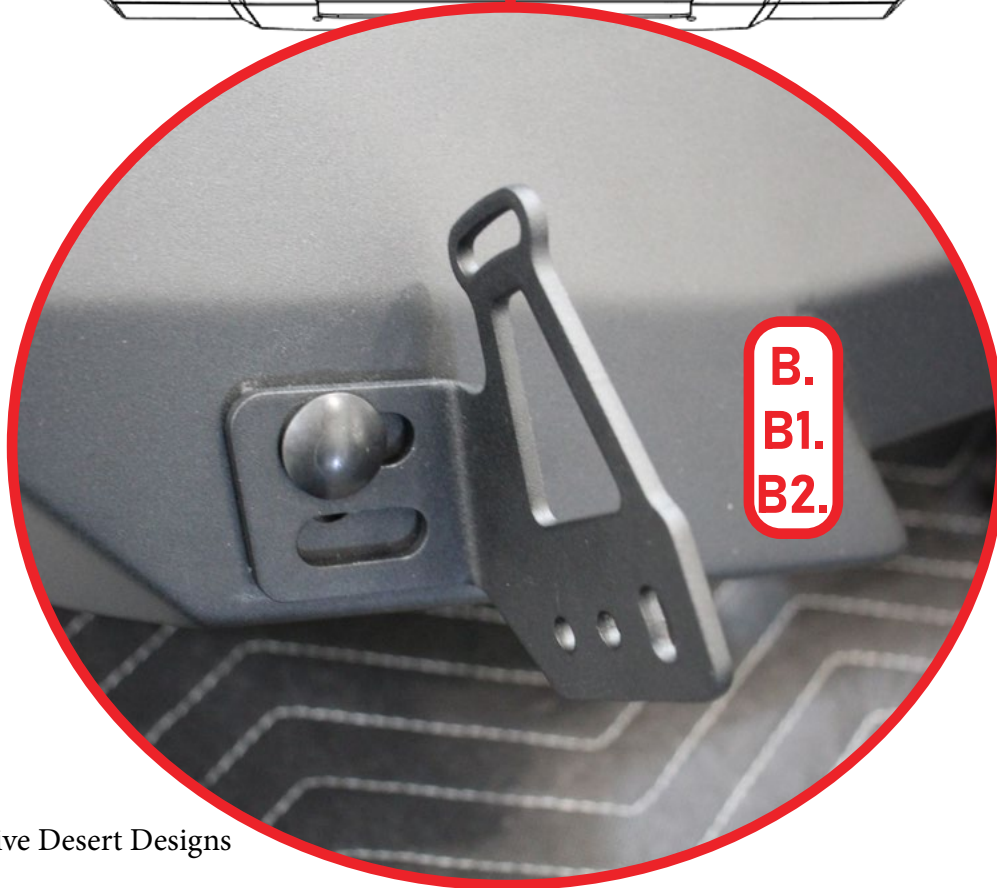
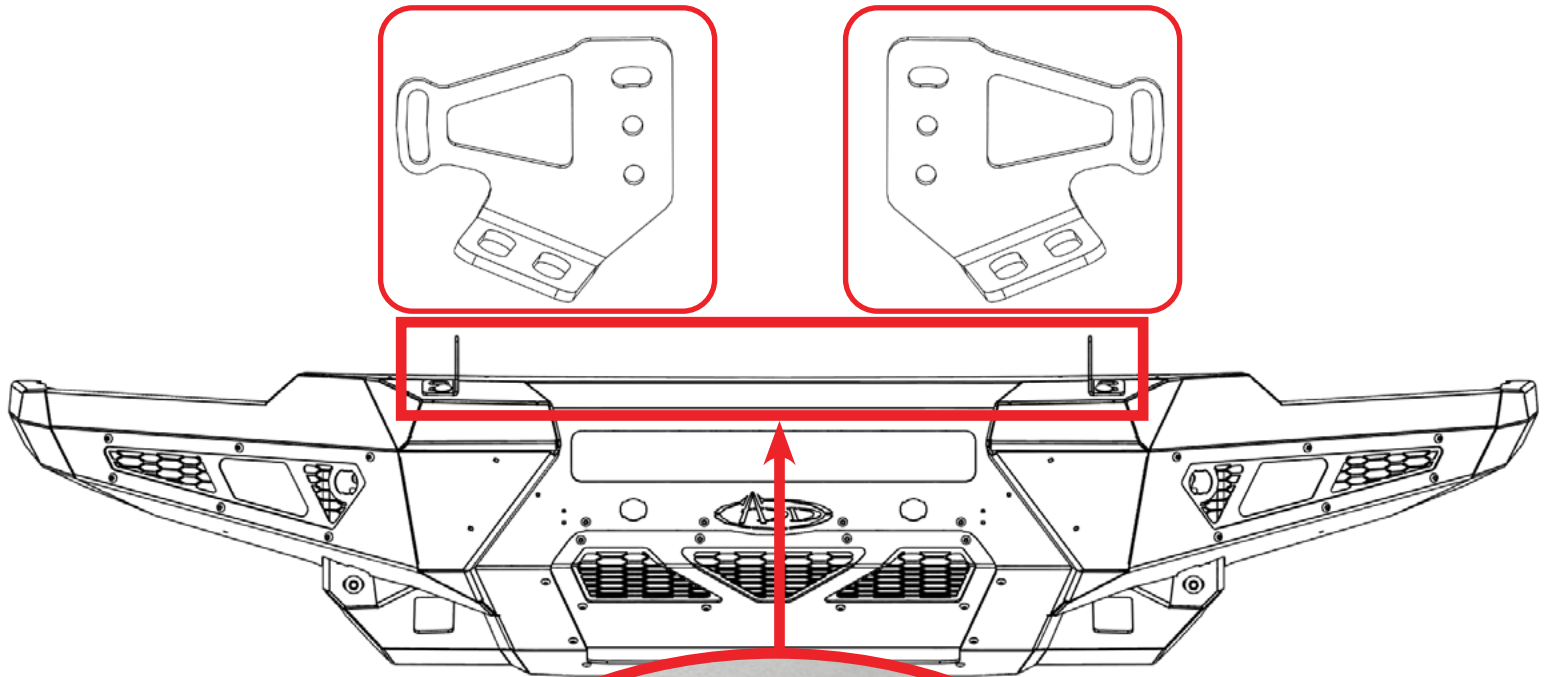



INSTALLATION GUIDE

HONEY BADGER FRONT BUMPER 23+ / FORD SUPER DUTY

INSTALL

STEP 23

Now would be a good time to install the lights to the bumper.

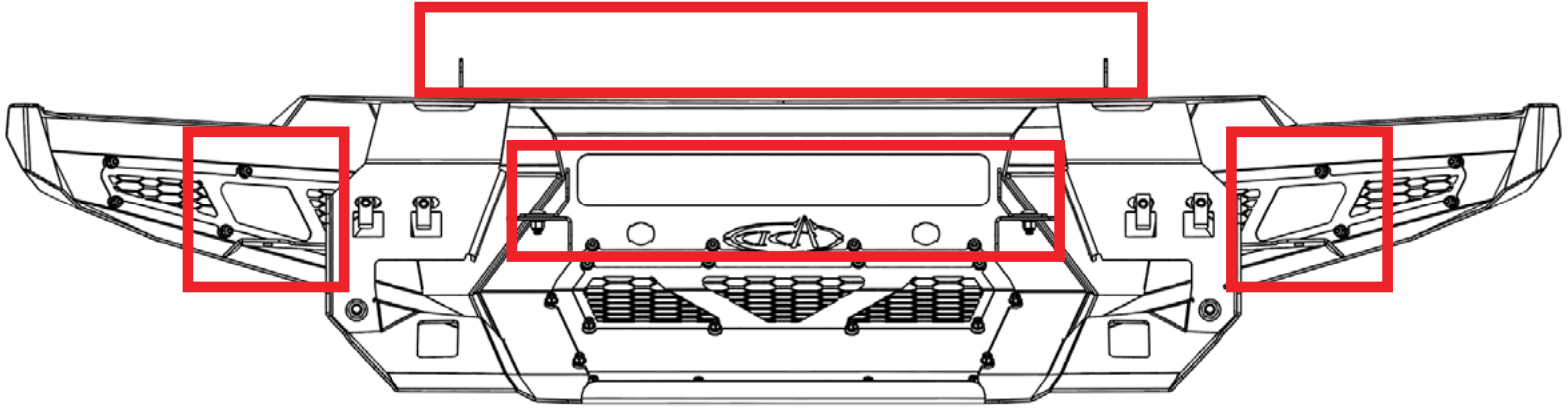



INSTALLATION GUIDE

HONEY BADGER FRONT BUMPER 23+ / FORD SUPER DUTY

INSTALL

□ STEP 24

With a helping hand, install the bumper with the provided (C1, C2, C3) 1/2" hardware using a (5/16 allen) and a (3/4 wrench).





INSTALLATION GUIDE

HONEY BADGER FRONT BUMPER 23+ / FORD SUPER DUTY

INSTALL

□ STEP 25

Using a (9/16 socket), you can now install your bumper with the provided (A, A1) 3/8" hardware.





INSTALLATION GUIDE

HONEY BADGER FRONT BUMPER 23+ / FORD SUPER DUTY

INSTALL

□ STEP 26

Plug in the wiring harness located on the driver side frame rail.





INSTALLATION GUIDE

HONEY BADGER FRONT BUMPER 23+ / FORD SUPER DUTY

FINAL

□ STEP 27

Stand back and enjoy your new ADD Honey Badger Front Bumper.

Check and re-tighten, if needed, all mounting bolts after 100 miles and periodically thereafter.



THIS PRODUCT IS PROTECTED BY ONE OR MORE U.S. PATENTS
WWW.ADDICTIVEDESERTDESIGNS.COM/PATENTS

FOR ADDITIONAL SUPPORT OR TECHNICAL QUESTIONS,
PLEASE CALL 480-671-0820 OR
EMAIL INFO@ADDICTIVEDESERTDESIGNS.COM